

RSDU-2X4AR

2 Channel Radio Signal Conditioning and Distribution Unit 100 kHz...2500 MHz, 50 Ω

Features

- wideband
- 2 identical sections with 4 level adjustable outputs (cascadable)
- frequency selective inputs
- wideband generator inputs
- through, amplifier and attenuator paths
- programmable DC current sinks
- DC voltage and current measurement function
- LAN remote control interface
- graphical user interface
- compact 19", 1 U design



Applications

- End-of-line test
- RF Test
AM, FM, DAB, DVB-T, GNSS,
SDARS /
- phantom supply test
- signal conditioning

Scope

RSDU-2X4AR is a compact device containing two complete identical RF conditioning sections (A and B). Via the LOC_IN/LOC_OUT wideband input/output the two sections of the RSDU-2X4AR can be combined to have 8 outputs with the same signal content. More than 8 outputs can be realized by cascading further RSDU-2X4AR devices without the cost of additional signal generators or power splitters.

A/B section description

Each section has 3 RF inputs with a distribution to 4 outputs.

Input combining and selection

2 of the 3 inputs are frequency selective and are combined with a duplexer network to a common signal. The 3rd input is wideband and allows to feed in generator signals or is used as input for cascading sections. All RF input ports are DC blocked and equipped with ESD discharging resistors.

Common path gain/attenuation

For signal conditioning the common signal path can be amplified, attenuated or passed through. An additional programmable attenuator allows level setting for the common signal in steps of 0.25 dB. Over all stages an overall level setting dynamic of approx. 85 dB is possible.

High dynamic amplification

The amplifier path contains a high dynamic amplifier which combines a low noise figure with high headroom in level. The high-level capability allows linear transmission of signals especially for signals with digital modulation.

Output paths

All RF output paths support the multi octave frequency range 100 kHz...2500 MHz. The outputs OUT1...OUT4 are individually adjustable in level over a 31.75 dB range in 0.25 dB steps in each channel.

Programmable DC current sinks

RSDU-2X4AR offers programmable internal current sinks. The architecture eliminates cabling to external DC loads and related electromagnetic interference (EMI) problems which are often caused by the external cables. Each of the outputs is equipped with an independent programmable current sink for phantom supply test. The current sinks are adjustable in the range 0...400 mA via remote interface.

Voltage and current measurement

Internal volt and ampere-meters allow precise read back of the phantom voltage and the current flow into the sink for each output channel.

Remote control

All settings of both sections of the RSDU-2X4AR can be remote-controlled via a common LAN remote interface with ASCII strings. Additionally, all path settings and the device identification can be queried via the remote interface.

Fine resolution in attenuation

The attenuators in the common path and the individual outputs allow total attenuations up to 63.5 dB in 0.25 dB steps for each channel.

High output-to-output isolation

The output splitter is designed as wideband, active multicoupler which is lossless in level. A second benefit is high decoupling of the output channels. A failing DUT does not have any influence to the other DUTs during the test.

Optical signalling

LEDs on the front side indicate the power status and the selected signal paths of both sections.

GUI (Graphic User Interface)

A GUI is provided for local laptop control of the device, e.g. to set signal paths and attenuator levels.

RF Specification

Parameter	Symbol	Min.	Typ.	Max.	Unit	Condition
impedance	Z_{in} / Z_{out}		50		Ohm	
sections	n_{CH}	2				A and B
low frequency	f_{min}		100	150	kHz	
high frequency	f_{max}	2500			MHz	
RF connectors	X_{RF}	SMA female				
inputs (in each section)						
DC voltage	U_{DC}			20	V	
ESD discharge resistor	R_{ESD}		4.7		k Ω	
maximum input power	$P_{in\ max}$			0	dBm	CW, no damage
<i>LOW IN:</i>						
low frequency	f_{LOW}		0.10	0.15	MHz	
high frequency	f_{HIGH}	800			MHz	
return loss	S_{11}		-11	-9	dB	$f < 500\ kHz$, THROUG/ATT
	S_{11}		-15	-12	dB	$f \geq 500\ kHz$, THROUG/ATT
	S_{11}		-7,5	-5	dB	$f < 80\ MHz$, AMP
	S_{11}		-15	-9	dB	$f \geq 80\ MHz$, AMP
<i>HIGH IN:</i>						
low frequency	f_{LOW}			1400	MHz	
high frequency	f_{HIGH}	2500			MHz	
return loss	S_{11}		-15		dB	
<i>LOC IN:</i>						
low frequency	f_{LOW}		0.10	0.15	MHz	
high frequency	f_{HIGH}	2500			MHz	
return loss	S_{11}		-10	-5	dB	$f < 500\ kHz$
			-18	-12	dB	$0.5\ MHz \leq f \leq 800\ MHz$
			-18		dB	$800\ MHz < f < 1400\ MHz$
			-15		dB	$f \geq 1400\ MHz$
common ATT range	a_{OUT}	0		31.75	dB	ATT_{COM}
common ATT step size	Δa		0.25		dB	ATT_{COM}
outputs (in each section)						
<i>LOC OUT:</i>						
low frequency	f_{LOW}		0.10	0.15	MHz	
high frequency	f_{HIGH}	2500			MHz	
return loss	S_{11}		-18	-12	dB	
insertion loss	S_{21}	-1.5	0	+1.5	dB	referred to LOC_IN
<i>OUT1....OUT8:</i>						
						($ATT_{COM} = ATT_{OUT} = 0\ dB$)
low frequency	f_{LOW}		0.10	0.15	MHz	
high frequency	f_{HIGH}	2500			MHz	
return loss	S_{22}		-18	-12	dB	
output ATT range	a_{OUT}	0		31.75	dB	ATT_{OUT}
output ATT step size	Δa		0.25		dB	ATT_{OUT}
1 dB compression	P_{1dB}	+5	+7		dBm	
3 rd order intercept	OIP3	+20	+24		dBm	$f \leq 800\ MHz$
	OIP3	+17	+21		dBm	$f \geq 1400\ MHz$
isolation	S_{23}		-24	-22	dB	neighbored outputs ($d=1$)
			-58	-50	dB	$d \geq 2$
phantom voltage range	U_{PH}	0		15	V	18 V absolute maximum
voltage measurement accuracy	dU_{MEAS}		± 0.01	± 0.03	V	$U_{PH} < 3\ V$



Parameter	Symbol	Min.	Typ.	Max.	Unit	Condition
	dU_{MEAS}		± 0.5	± 1.0	%	$U_{PH} \geq 3 V$
volt. meas. resolution	ΔU_{MEAS}		4.4		mV	
current sink range	I_{SINK}	0		400	mA	
current meas. accuracy	dI_{MEAS}		± 0.2	± 0.5	mA	$I \leq 200mA$
			± 0.4	± 0.8	mA	$I > 200mA$
current meas. resolution	ΔI_{MEAS}		0.11		mA	
current sink accuracy	dI_{SINK}		± 0.3	± 0.7	mA	$I \leq 200mA, U_{PH} \geq 1.5 V$
			± 0.5	± 1.0	mA	$I > 200mA, U_{PH} \geq 1.5 V$
current step size	ΔI_{SINK}		0.11		mA	
total DC dissipation	P_{DC}			24	W	
THROUGH paths ($ATT_{COM} = ATT_{OUT} = 0dB$)						
gain	S_{21}	2,0	3,5	5,0	dB	$f < 470 MHz$
		0,0	2,0	3,5	dB	$f \geq 470 MHz$
noise figure	NF		13	17	dB	
AMP paths ($ATT_{COM} = ATT_{OUT} = 0dB$)						
gain	S_{21}	26.5	28.0	29.5	dB	$f < 200 MHz$
		23.5	26.0	29.0	dB	$f \geq 200 MHz$
noise figure	NF		20		dB	@ 1 MHz
			6.0	8.0	dB	$f \geq 70 MHz$
ATT paths ($ATT_{COM} = ATT_{OUT} = 0dB$)						
gain	S_{21}	-27.5	-26.0	-24.5	dB	$f < 200 MHz$
		-29.0	-27.5	-25.5	dB	$f \geq 200 MHz$
noise figure	NF		45		dB	

Common Specification

Parameter	Symbol	Min.	Typ.	Max.	Unit	Condition
voltage supply range	U_{AC}	90	230	260	V	50 / 60 Hz AC
power consumption	P_{AC}		12	50	W	
power socket	X_{AC}	IEC-60320 C14				country specific mains cable
Dimensions and weight						
dimensions	W x H x D	approx. 482 x 44 x 210			mm	19" 1 U, without connectors and handles
weight	m		3.7		kg	
Environment conditions						
operating temp. range	T_o	+5		+45	°C	
storage temp. range	T_s	-40		+70	°C	
Remote interfaces						
remote ports	LAN	10/100BaseT	TCP/IP			RJ45
	USB	2.0 (high speed)				USB type B
Product conformity						
Electromagnetic compatibility	EU: in line with EMC directive (2014/30/EC)					applied harmonized standards: EN 61326-1 (for use in industrial environment), EN 61326-2-1, EN 55011 (class B), EN 61000-3-2, EN 61000-3-3
Electrical safety	EU: in line with low voltage directive (2014/35/EC)					applied harmonized standard: EN 61010-1
Ordering information	RSDU-2X4AR	P/N: 1810.6012.1				



Block diagram

Section A

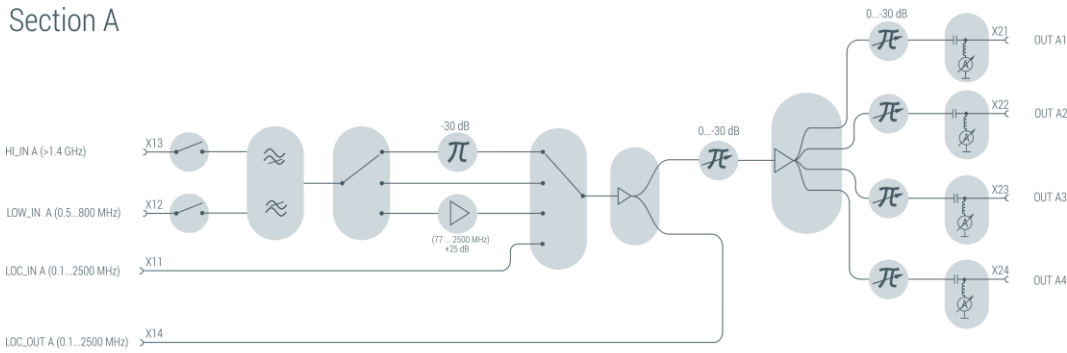

Section B

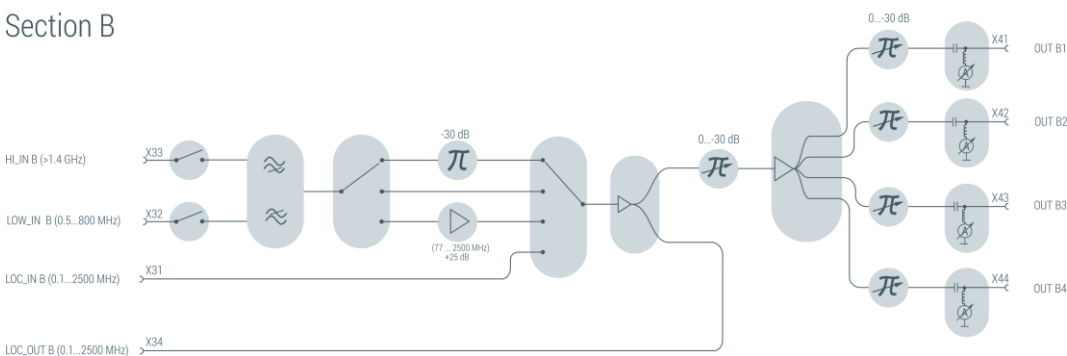

Application example

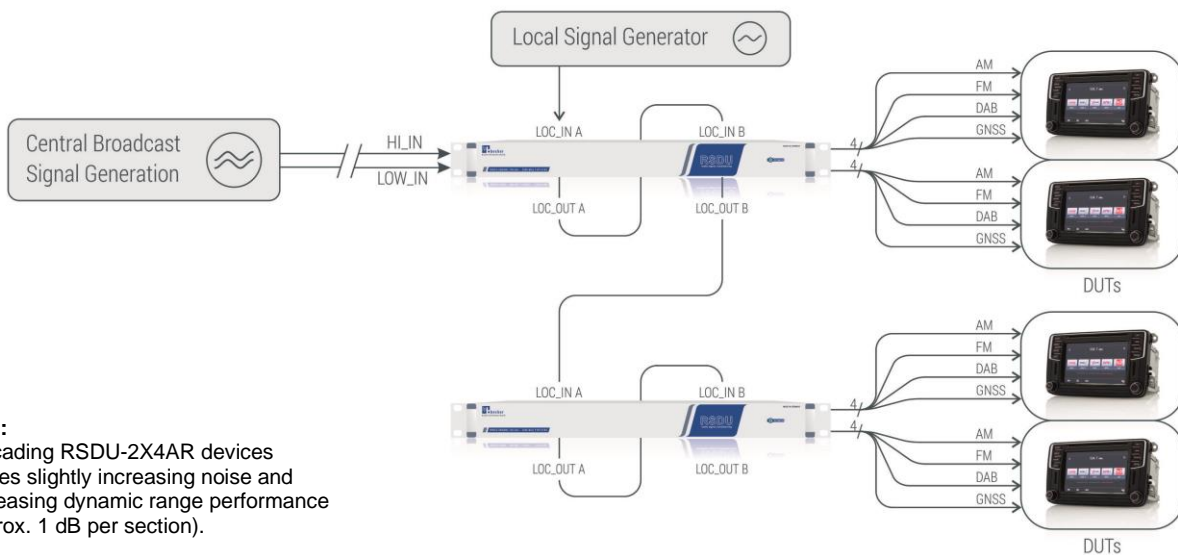

Note:
Cascading RS2U-2X4AR devices causes slightly increasing noise and decreasing dynamic range performance (approx. 1 dB per section).



S-Parameters (typical responses)

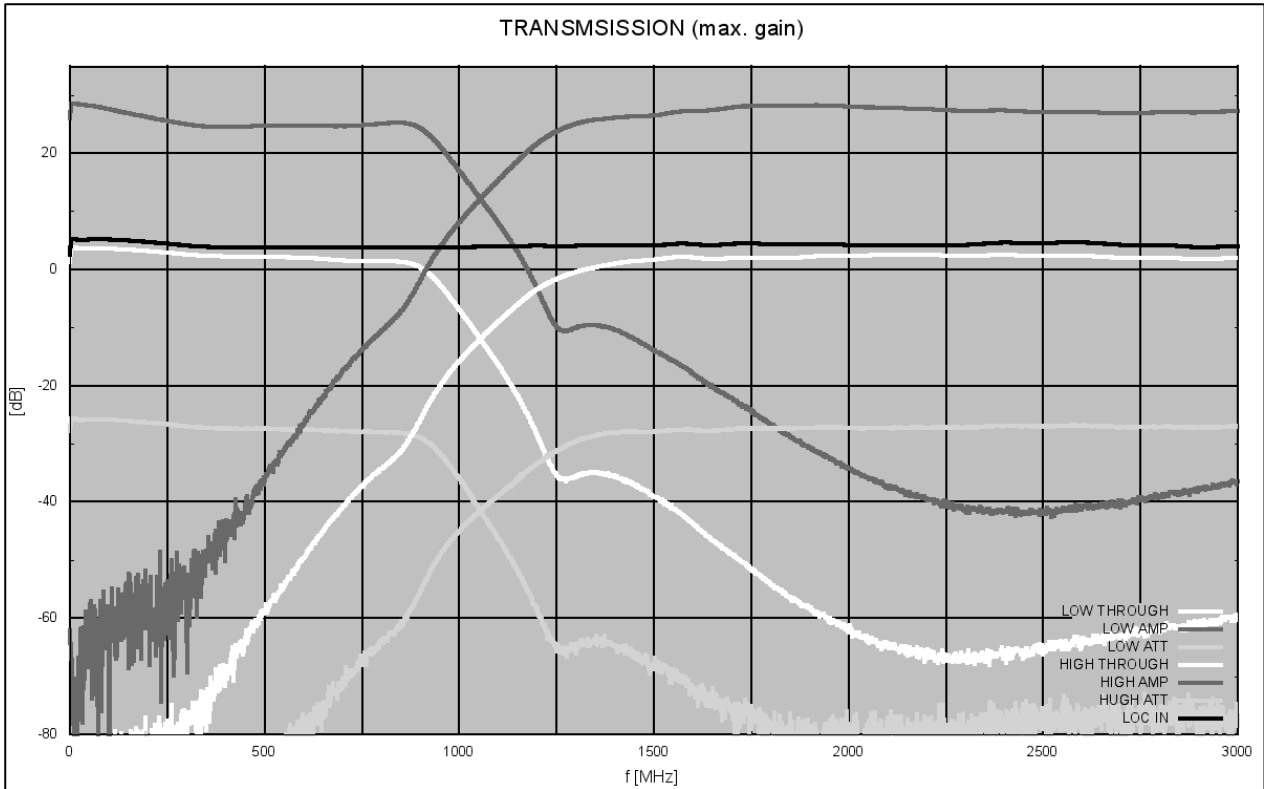

Noise figure AMP path (typical values)

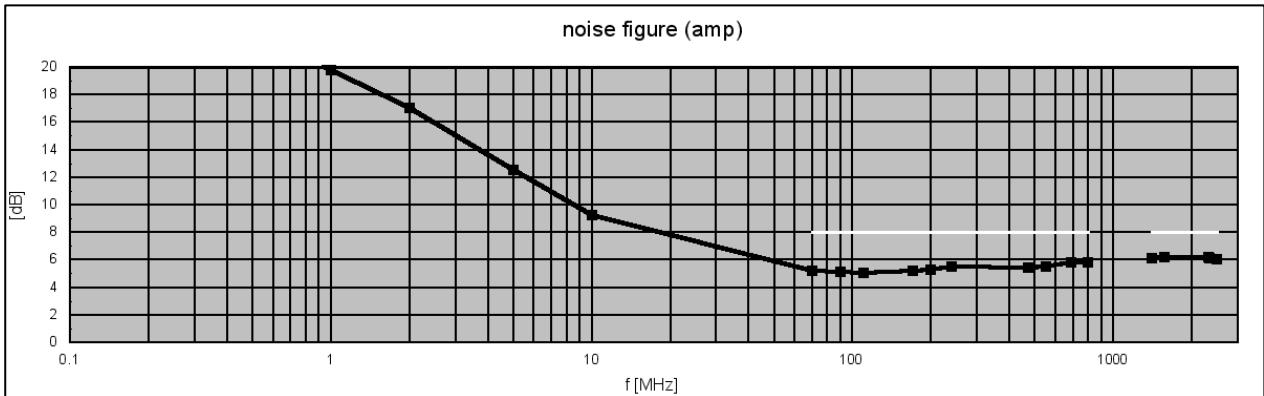

1 dB compression (typical values)

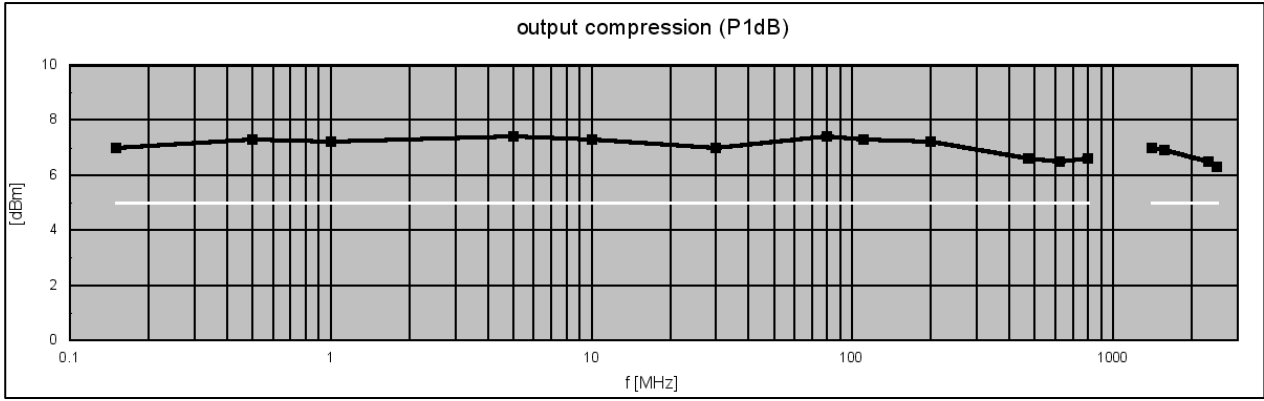

3rd order intercept (typical values)

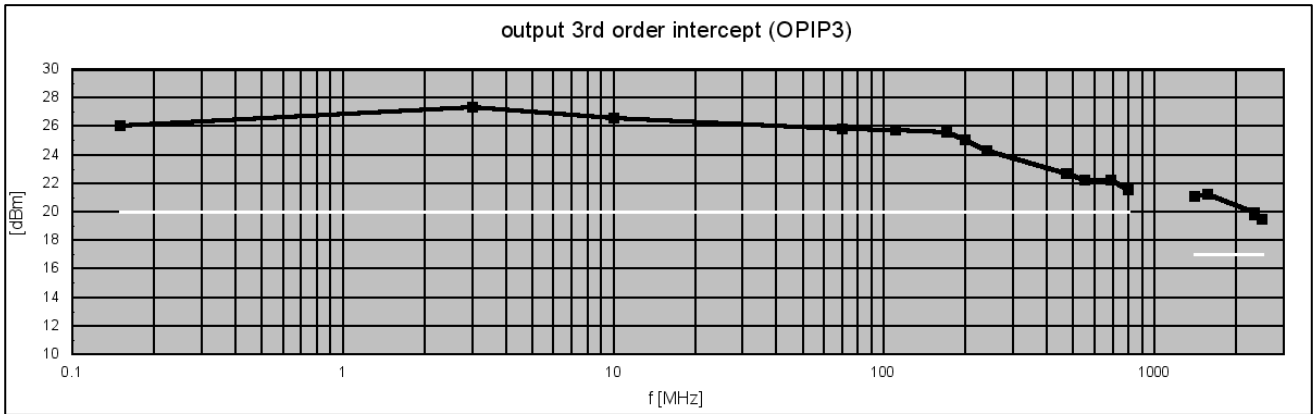

Appearances

Front View



Rear View



Dimensions

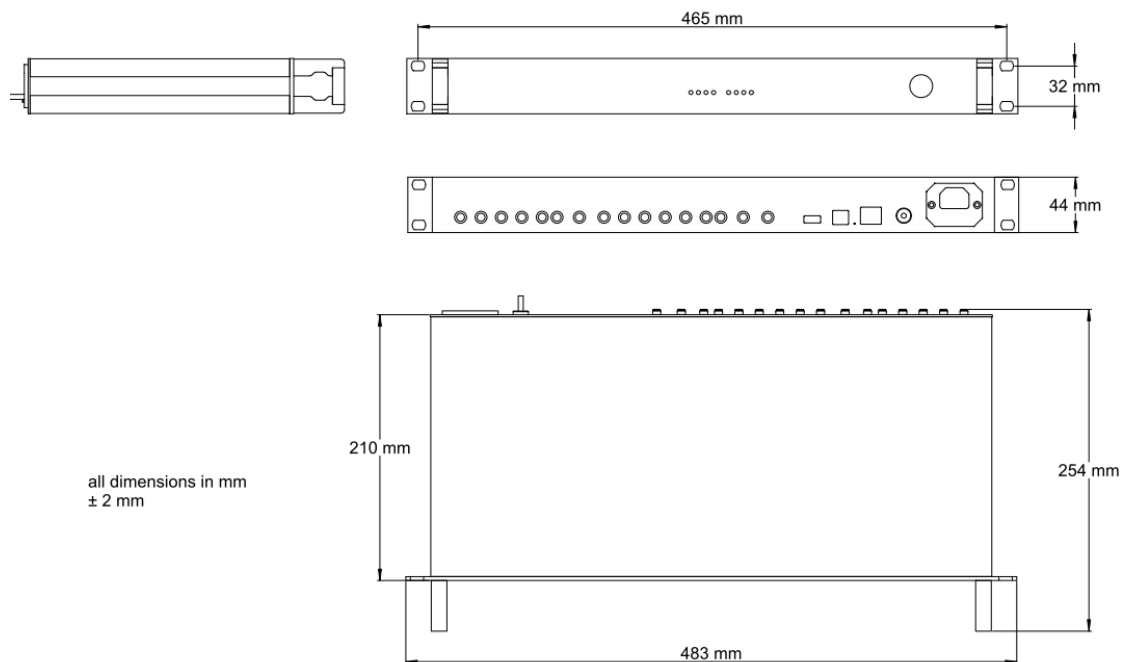

Related Products

Product	Description	P/N
WSDU-1X8AR	8 Way, High Dynamic, Signal Conditioning Multicoupler Device 100 kHz ... 4000 MHz AC or DC supply	1807.6302
WSDU-1X8LR	High Dynamic 1X8 Multicoupler for Broadcast Signals 100 kHz ... 4000 MHz AC or DC supply	1107.6152
WSDU-2X4LR	High Dynamic 2 Section 4 Way Multicoupler for Broadcast Signals 100 kHz ... 4000 MHz AC or DC supply	1107.6252

